

TO :	 Jinyoung Contech Co., Ltd. #501. 12 MARIOTOWER, GURO3-DONG, GURO-KU, SEOUL, KOREA TEL : 82-2-890-6400 FAX : 82-2-890-6406 HOME PAGE : http://www.jyct.com/	Issued Date : 2007-11-05
		Page : 15ages
TFT LCD MONITOR INOV70-T”		USER’S MANUAL

INOV70 - T

Table of Contents

1. Safety Precaution	-----	4
1.1 Set up and General Handling Precaution		4
1.2 Operating Precaution		4
1.3 Cleaning of the equipment and management Precaution		4
2. Introduction	-----	5
3. Specification	-----	5
Compatibility of Vertical Frequency	-----	6
4. Block Diagram	-----	7
5. LCD DISPLAY SYSTEM setting up and how to adjustment	-----	8
6. Connector	-----	11
7. Dimensions	-----	15

1. Safety Precaution

The safety recommendations outlined in this section are to be read, understood and followed before operating the product. Keep this information in a safe place for future reference. Failure to comply with any of the following safety procedures could result in serious hazard.

1.1 Set up and General Handling Precaution

1. Please set up this equipment in clean area where there is no dust.
2. Do not set up the equipment on shaky stand, on incline surface or surfaces subject to frequent vibration.
3. This product is intended for indoor use only.
4. Do not press heavily the LCD panel with sharp objects, such as nails.
5. When set up the equipment, be extremely careful.

You may get injured from the sharp parts, such as steel covers

6. When transporting the equipment, be extremely careful.
7. When transporting the equipment, hold the body with two hands letting LCD screen goes up.
8. Do not lift the equipment up holding LCD panel itself.
9. The Fluorescence lamp of LCD panel, this equipment, includes mercury.

Do not waste or bury without leave. When waste, follow the related laws and regulations.

1.2 Operating Precaution

1. Do not place the equipment in areas subject to direct sunlight and close to heating elements.
 2. Do not block ventilate openings. Fire may result due to the rising of the inner temperature.
 3. Do not disassemble the back cover except a repairing engineer. This could result electrical shock
 4. If you find any unusual action or break down while you using this equipment,
immediately unplug the DC power and contact your retailer or Jinyoung Contech Support Help Desk.
 5. Do not take apart or modify the equipment. Fire or electrical shock may result.
 6. Do not spill liquids on the equipment. Do not set up in areas where there is high humidity
and water splashes.
 7. Do not plug in/unplug the DC power with wet hands. Fire or electrical shock may result.
 8. Do not plug the equipment into outlets with voltage other than the specified voltage.
Incorrect voltage may result in fire or electrical shock.
 8. When unplugging the DC power, always pull on main body. Pulling on the cord may damage
the wires and lead to fire or electrical shock.
 9. Always plug the DC power in all the way. If it is not plugged in completely, fire or electrical shock
may result.
 10. When not in use for extended period, such as long weekend and moving the equipment,
unplug the DC power for safety. If dust accumulates in this area, it may result in fire.
-

11. Do not connect excessive numbers of plugs into one electrical outlet.
Fire or electrical shock may result.
12. The DC power is certain to be connected to electrical outlet that has an earth device.
13. Do not spill flammable liquid on the equipment. Fire or electrical shock may result.
14. Set up the outlet in areas where close to the equipment, easily accessible and easily operative.

1.3 Cleaning of the equipment and management Precaution

1. Do not take apart or modify the equipment. Fire or electrical shock may result.
2. When cleaning the equipment, always unplug the DC power.
3. When cleaning the equipment, do not use flammable liquids, such as alcohol, benzene or thinners.
4. If you strongly wipe down the surface of this equipment with a sponge and a piece of cloth, in case of plastic equipment, the coating may be fallen away.
5. When cleaning the equipment, use a water-moistened cloth that is well wrung out.
6. If the cleaning of the equipment inside necessary, contact Jinyoung Contech Support Help Desk.

2. Introduction

This unit is LCD monitor using TFT Color LCD. It basically supports Analog R,G,B signals, H-Sync, V-Sync. This unit has OSD function for the best quality of display on characteristic of each VGA Card.

3. Specification

Panel	Item	Description
Features	Size	7"
	Resolution	WVGA
	Pixel Format	800(H) By 480(V)
	Pixel Pitch	0.1905(H) x 0.1905(W) (mm)
	Number of Colors	16.7M (8-bit)
	Contrast Ratio	300 : 1 (Typ)
	Brightness	350 (cd/m ²)
	Viewing Angle (U/D/L/R)	50/60/65/65
	Interface	TTL
	Input Signal	PC Connectivity
Display	Functions	OSD Functions
Power		DC 12[V] Typ 0.5[A]
Environmental Considerations	Storage Temperature	-20 ~ 60°C
	Operating Temperature	0 ~ 50°C
Dimensions	W x H x D	181.4 x 114.5 x 52 mm
Weight		Net : 500 kg

Compatibility of Vertical Frequency

Mode	Resolution	Horizontal freq.(KHz)	Vertical freq.(Hz)	Pixel Clock (MHz)
VESA MODES				
VGA	640 x 350 x 85Hz			
	640 x 400 x 85Hz			
	720 x 400 x 85Hz			
	640 x 480 x 60 Hz	31.469	59.941	25.175
	640 x 480 x 72 Hz	37.861	72.810	31.500
	640 x 480 x 75 Hz	37.500	75.000	31.500
WVGA	800 x 480 x 60 Hz	29.820	59.997	29.580
	800 x 480 x 60Hz(Optional)	37.207	60.011	38.100
SVGA	800 x 600 x 56 Hz	35.156	56.250	36.000
	800 x 600 x 60 Hz	37.879	60.317	40.000
	800 x 600 x 72 Hz	48.077	72.188	50.000
	800 x 600 x 75 Hz	46.875	75.000	49.500

4. Block Diagram

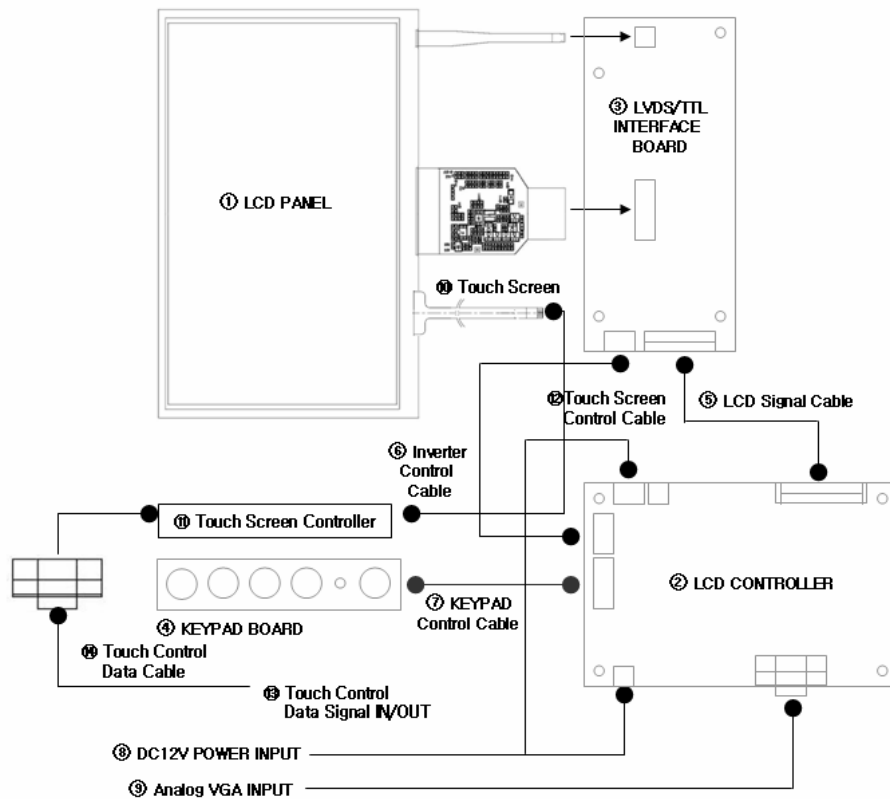

Note

1. LCD PANEL
2. LCD CONTROLLER CARD, JY-LSX300
3. LVDS/TTL INTERFACE BOARD
4. Keypad Board, Function Control
5. LCD Signal Cable
6. Inverter Cable
7. Keypad Control Cable
8. DC12V Power Input (Adaptor or Power Module)
9. PC Analog VGA Input
10. Touch Screen
11. Touch Screen Controller
12. Touch Screen Control Cable
13. Touch Control Data Cable

5. LCD DISPLAY SYSTEM setting up and how to adjustment

Controls	Description	OSD B'd R11 5Key
On/Off	Board power on / off Control	PW
Menu	Turn on or Turn off OSD Main Menu.	OSD
SEL	Enter to Main item or sub item.	SEL
UP	Increase a set value or move to up.	UP
DN	Decrease a set value or move to down.	DN
-	-	-



OSD B'D R11

OSD function

Menu Button select :

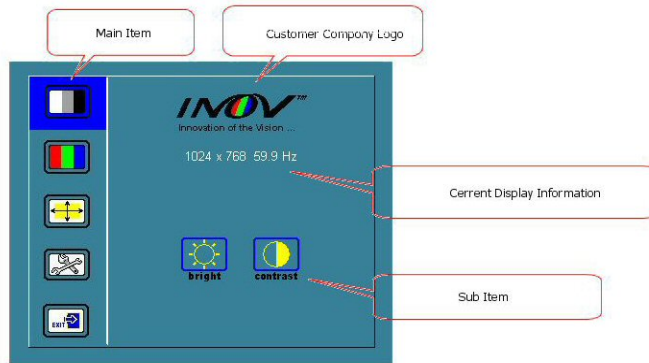



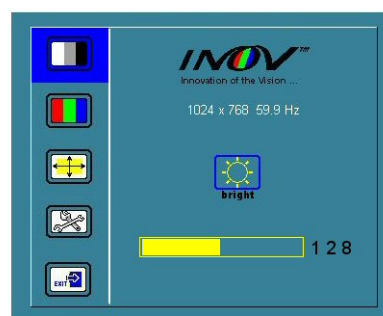
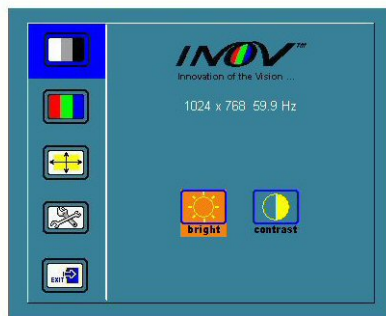

SEL Button select :

Sub item select :



Bright & Contrast Item :

	 Brightness Item	 1 2 8 Adjust Panel Brightness Level.
	 Contrast Item	 1 2 8 Adjust Panel Contrast Level.

Color Control Item :















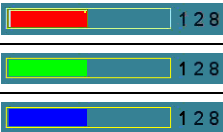















	 ColorAdjust Item	<input type="button" value="OK"/> <input type="button" value="Cancel"/>	Adjust Color Level automatically. If the adjusted image is good, select "ok" or not, select "cancel" and adjust again.
	 Super RGB Item	<input type="button" value="OK"/> <input type="button" value="Cancel"/>	Setting up s-RGB mode. Automatic adjustment for Color Level.
	 Color Temperature Item	 UserColor	 1 2 8 User can adjust warmness as users please.
		 4200K	Adjust the warmness of the image displayed. The higher temperature the coolest image looks like.
		 5000K	The lower temperature the warmest image looks like.
	 6500K		
	 7500K		
 9300K			

Image Control Item :



	 Image Auto Adjust Item	<input type="button" value="OK"/> <input type="button" value="Cancel"/>	Auto adjustment H,V Position of image and Clock & Phase. If the result adjusted is good, select "ok" or not, select "cancel" and adjust again
	 H-Total Adjust Item	 1 2 8 Adjust increase/decrease image of horizontal size	
	 Phase Adjust Item	 1 2 8 Adjust data sampling position of image.	
	 H-Position Adjust Item	 1 2 8 Move the image horizontally.	
	 V-Position Adjust Item	 1 2 8 Move the image horizontally.	

OSD utility Item :

	 OSD Display Time Adjust Item	Adjust OSD display time.	
	 OSD Adjust Item	 OSD H-Position Adjust Item  OSD V-Position Adjust Item	Move the OSD menu horizontally.
	 User Value Initial Item	Reset user's setting up value	
	 Image Sharpness Adjust Item	 1 2 8 Adjust sharpness of the image.	
	 DOS Mode Select Item	Adjust Dos screen resolution to 640 x 400 or 720 x 400	

	Menu Exit Item	OSD Exit
---	----------------	----------

Warning Message item

 No Cable	No Cable	In case of not connected PC VGA Cable with A/D Controller, the message "No Cable " is displayed.
 No Signal	No signal	If there is no PC VGA Signal(R,G,B H-SYNC, V-SYNC), the message "No Signal " is displayed.
 Out of Range	Out of Range	In case of detecting the mode (resolution) that cannot be totally supported by LCD. In order to remove the phenomenon, it should be adjusted into the mode (resolution) that can be supported by LCD.

6. Connector

Summary Connectors :

Ref	Purpose	Description
CN1	VGA analog Input	DB-15 way high density 3 row
CN1-B	VGA analog Input (alternative)	Molex 53014-1510 (matching type :51004-1500)
CN3	Panel Power Support(alternative)	Molex 53015-0410 (matching type :51004-0400)
CN4	Panel Power & LVDS Signal	Hirose DF14-30P-1.25H (matching type : DF14-30S-1.25C)
CN5	Keypad Input & LED Signal	Molex 53015-1010 (matching type :51004-1000)
CN6	Main Power Input	DC Power jack, 2.5mm contact pin diameter
CN7	Main Power Input(alternative)	Molex 5268 – 4(or 22-05-0745) (matching type : 5264-4 or 50-37-5043)
CN8	Backlight Inverter	Molex 53015-0710 (matching type :51004-0700)
CN9	Touch Control Power Supprt	Molex 5268 – 3(or 22-05-0735) (matching type : 5264-3 or 50-37-5033)
JP1	Panel Power Select	Header pin 2.54 pitch 2x3
JP2	Touch Power Select	Header pin 2.54 pitch 2x2

CN1- VGA analog Input : DB-15 way high density 3 row

PIN	SYMBOL	DESCRIPTION
1	RED	Red, analog
2	GREEN	Green, analog
3	BLUE	Blue, analog
4	NC	No connection
5	CHK_CBL	VGA cable connection check
6	AGND	Analog ground red
7	AGND	Analog ground green
8	AGND	Analog ground blue
9	DDC5V	+5V power supply for DDC (optional)
10	GND	Digital ground
11	NC	No connection
12	D_SDA	DDC serial data
13	HS_IN	Horizontal sync or composite sync, input
14	VS_IN	Vertical sync, input
15	D_SCL	DDC serial clock

CN1-B – alternative VGA IN : Molex 53014-1510 (matching type :51004-1500)

PIN	SYMBOL	DESCRIPTION
1	D_SCL	DDC serial clock
2	VS_IN	Vertical sync, input
3	HS_IN	Horizontal sync or composite sync, input
4	D_SDA	DDC serial data
5	NC	No connection
6	GND	Digital ground
7	DDC5V	+5V power supply for DDC (optional)
8	AGND	Analog ground blue
9	AGND	Analog ground green
10	AGND	Analog ground red
11	CHK_CBL	VGA cable connection check
12	NC	No connection

13	BLUE	Blue, analog
14	GREEN	Green, analog
15	RED	Red, analog

CN3 - Panel Power Support(alternative) : Molex 53015-0410 (matching type :51004-0400)

PIN	SYMBOL	DESCRIPTION
1	Panel Power	Panel power supply(+3.3V/+5V/+12V)
2	Panel Power	Panel power supply(+3.3V/+5V/+12V)
3	GND	Ground
4	GND	Ground

CASE 2 : LVDS Single 8 Bit & Single 6 Bit Interface

LVDS Single 8 Bit Interface		LVDS Single 6 Bit Interface		DESCRIPTION
PIN	SYMBOL	PIN	SYMBOL	
1	GND	1	GND	Ground
2	TXO3+	2	NC	Positive Transmission Data of Pixel 3
3	TXO3-	3	NC	Negative Transmission Data of Pixel 3
4	GND	4	GND	Ground
5	TXOC+	5	TXOC+	Positive Sampling Clock
6	TXOC-	6	TXOC-	Negative Sampling Clock
7	GND	7	GND	Ground
8	TXO2+	8	TXO2+	Positive Transmission Data of Pixel 2
9	TXO2-	9	TXO2-	Negative Transmission Data of Pixel 2
10	TXO1+	10	TXO1+	Positive Transmission Data of Pixel 1
11	TXO1-	11	TXO1-	Negative Transmission Data of Pixel 1
12	TXO0+	12	TXO0+	Positive Transmission Data of Pixel 0
13	TXO0-	13	TXO0-	Negative Transmission Data of Pixel 0
14	GND	14	GND	Ground
15	GND	15	GND	Ground
16	NC	16	NC	No Connection
17	NC	17	NC	No Connection
18	GND	18	GND	Ground
19	NC	19	NC	No Connection
20	NC	20	NC	No Connection
21	GND	21	GND	Ground
22	NC	22	NC	No Connection
23	NC	23	NC	No Connection
24	NC	24	NC	No Connection
25	NC	25	NC	No Connection
26	NC	26	NC	No Connection
27	NC	27	NC	No Connection
28	Panel Power	28	Panel Power	PANEL Support power (DC +3.3V / +5V / +12V / Extend Voltage)
29	Panel Power	29	Panel Power	PANEL Support power (DC +3.3V / +5V / +12V / Extend Voltage)
30	Panel Power	30	Panel Power	PANEL Support power (DC +3.3V / +5V / +12V / Extend Voltage)

NOTE : NC → No Connection

CN5 - Keypad Input & LED Signal : Molex 53015-1010 (matching type :51004-1000)

PIN	SYMBOL	DESCRIPTION
1	MENU	KEY FUNCTION "MENU"
2	SEL	KEY FUNCTION "SEL"
3	UP	KEY FUNCTION "UP"
4	DOWN	KEY FUNCTION "DOWN"
5	ON/OFF	KEY FUNCTION "ON/OFF"
6	EXTEND1	EXTEND KEY 1
7	EXTEND2	EXTEND KEY 2
8	LED_RED	LED RED Signal
9	LED_GRN	LED Green Signal
10	GND	Ground

CN6 – Main Power DC+12V Input Jack

PIN	DESCRIPTION
1	+ 12VDC In
2	Ground

CN7 - Main Power Input(alternative) : Molex 5268 – 4(or 22-05-0745) (matching type : 5264-4 or 50-37-5043)

PIN	DESCRIPTION
1	+ 12VDC In
2	+ 12VDC In
3	Ground
4	Ground



CN8 – Inverter Connection : Molex 53015-0710 (matching type :51004-0700)

PIN	SYMBOL	DESCRIPTION
1	+12V	+12VDC, backlight power supply
2	+12V	+12VDC, backlight power supply
3	+5V	+5VDC, backlight power supply
4	BKLT_EN	On/Off control
5	BKLT_ADJUST	Dim Control
6	GND	Ground
7	GND	Ground



CN9 – Touch screen Controller Power supply : Molex 5268 – 3(or 22-05-0735) (matching type : 5264-3 or 50-37-5033)

PIN	DESCRIPTION
1	DC power supply (+5V / +12V) *see JP2
2	Ground
3	Ground

JP1 – Panel power selection jumper

SELECTION	DESCRIPTION
 +12V +5V +3.3V JP1	+3.3V output
 +12V +5V +3.3V JP1	+5V output
 +12V +5V +3.3V JP1	+12V output

JP2 – Touch Controller power selection jumper

SELECTION	DESCRIPTION
 +5V +12V JP2	+5V output
 +5V +12V JP2	+12V output

7. Dimensions

